

|                    |                       |                          |
|--------------------|-----------------------|--------------------------|
| PCB Information    | Name: DFRD159[V1.3]   | Thickness: 1.6mm         |
| Engineer: Strictus | Top SolderMask: Black | Bottom SolderMask: Black |
| Date: 20200812     | Top Silkscreen: White | Bottom Silkscreen: White |

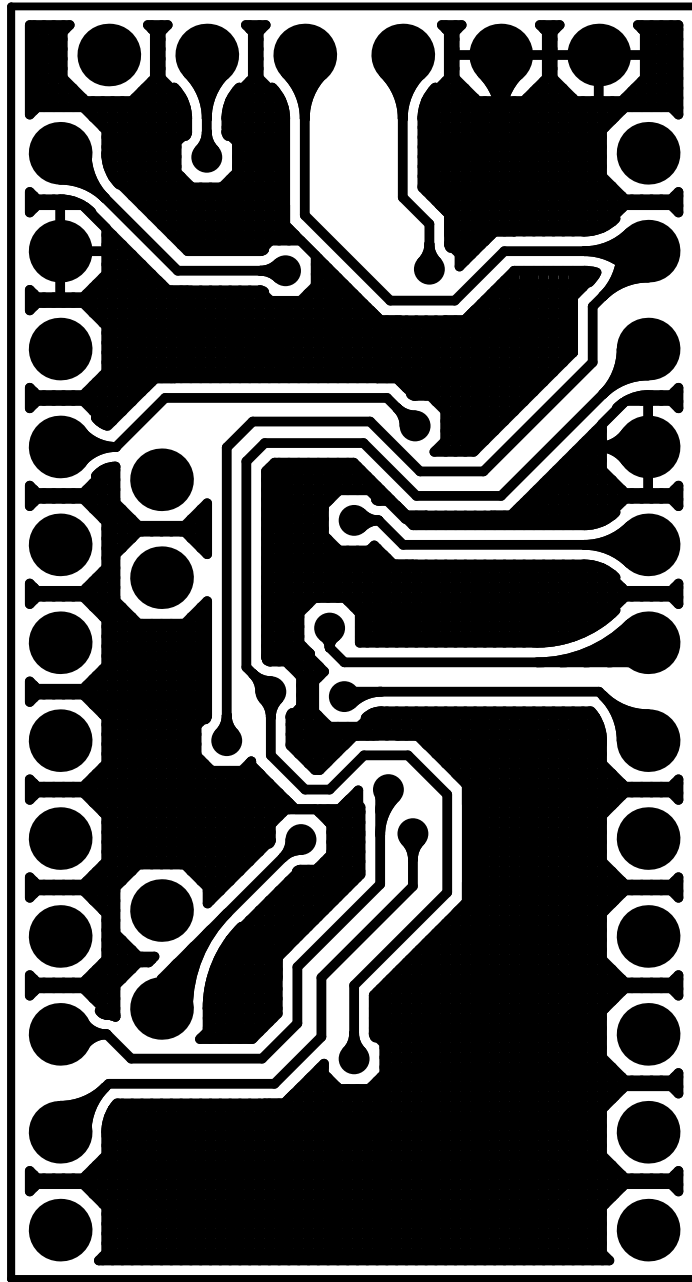

|                        |                       |                          |
|------------------------|-----------------------|--------------------------|
| <b>PCB Information</b> | Name: DFR0159[V1.3]   | Thickness: 1.6mm         |
| Engineer: Strictus     | Top SolderMask: Black | Bottom SolderMask: Black |
| Date: 20200812         | Top Silkscreen: White | Bottom Silkscreen: White |

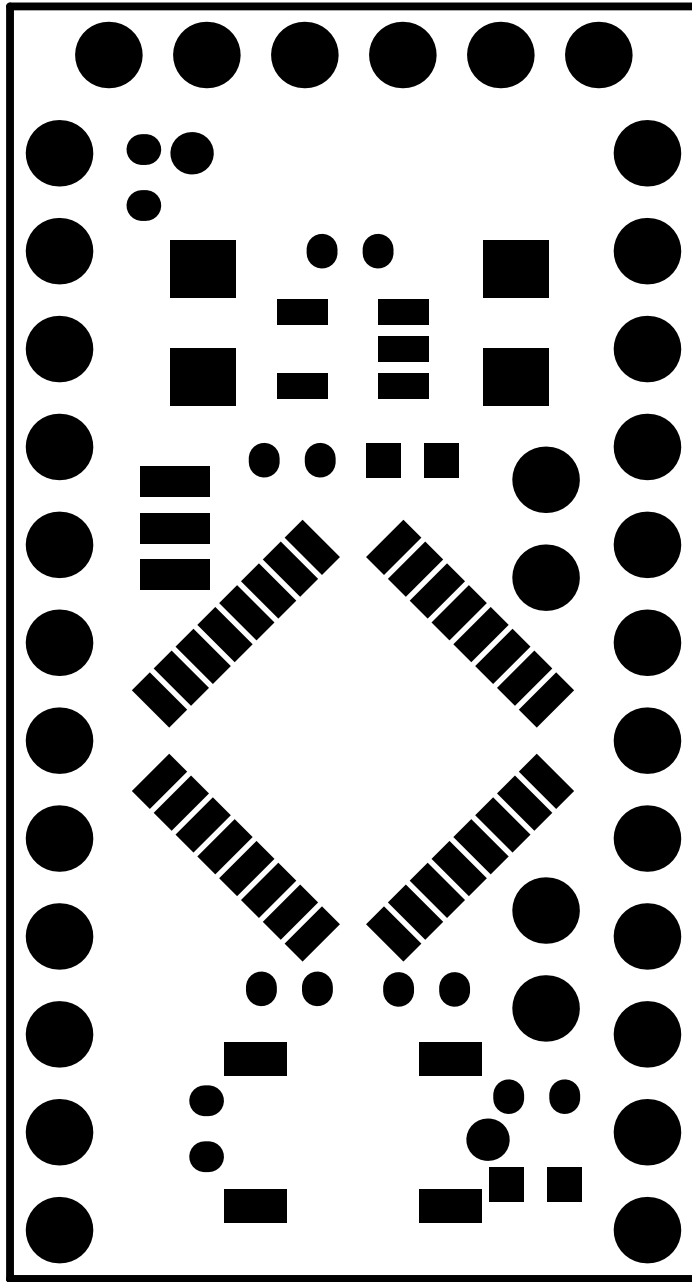

|                    |                       |                          |
|--------------------|-----------------------|--------------------------|
| PCB Information    | Name: DFRD159[V1.3]   | Thickness: 1.6mm         |
| Engineer: Strictus | Top SolderMask: Black | Bottom SolderMask: Black |
| Date: 20200812     | Top Silkscreen: White | Bottom Silkscreen: White |

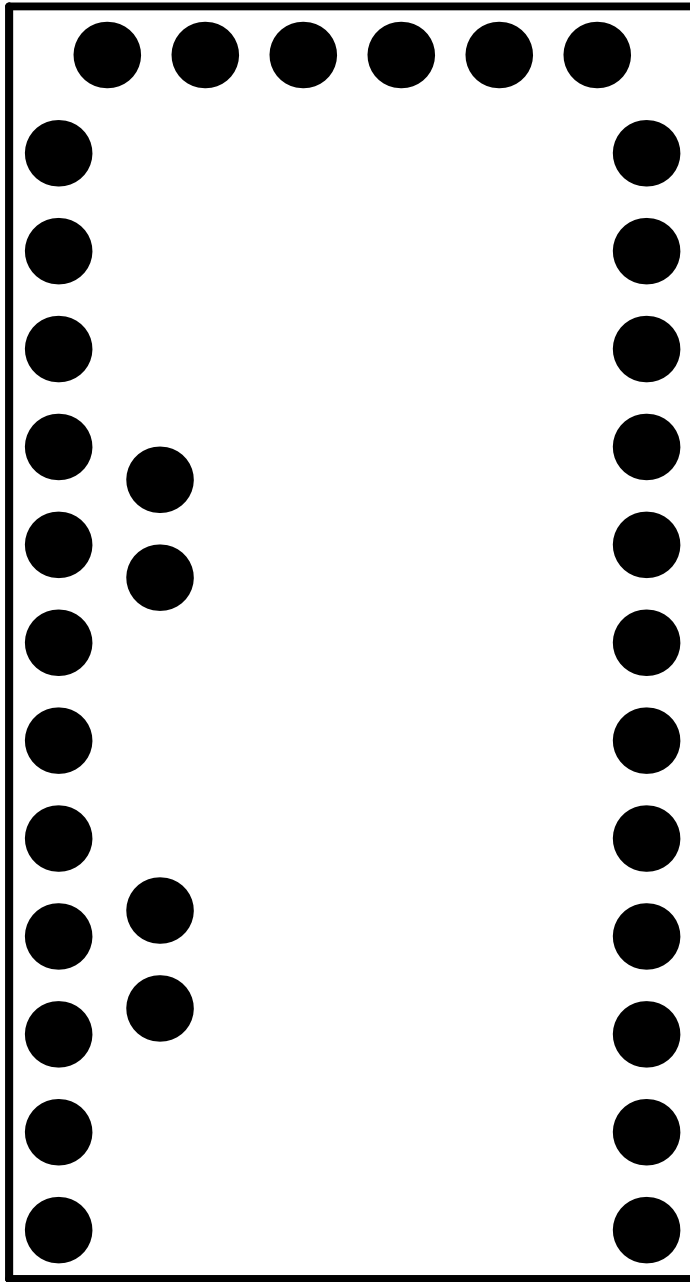

|                        |                       |                          |
|------------------------|-----------------------|--------------------------|
| <b>PCB Information</b> | Name: DFR0159[V1.3]   | Thickness: 1.6mm         |
| Engineer: Strictus     | Top SolderMask: Black | Bottom SolderMask: Black |
| Date: 20200812         | Top Silkscreen: White | Bottom Silkscreen: White |

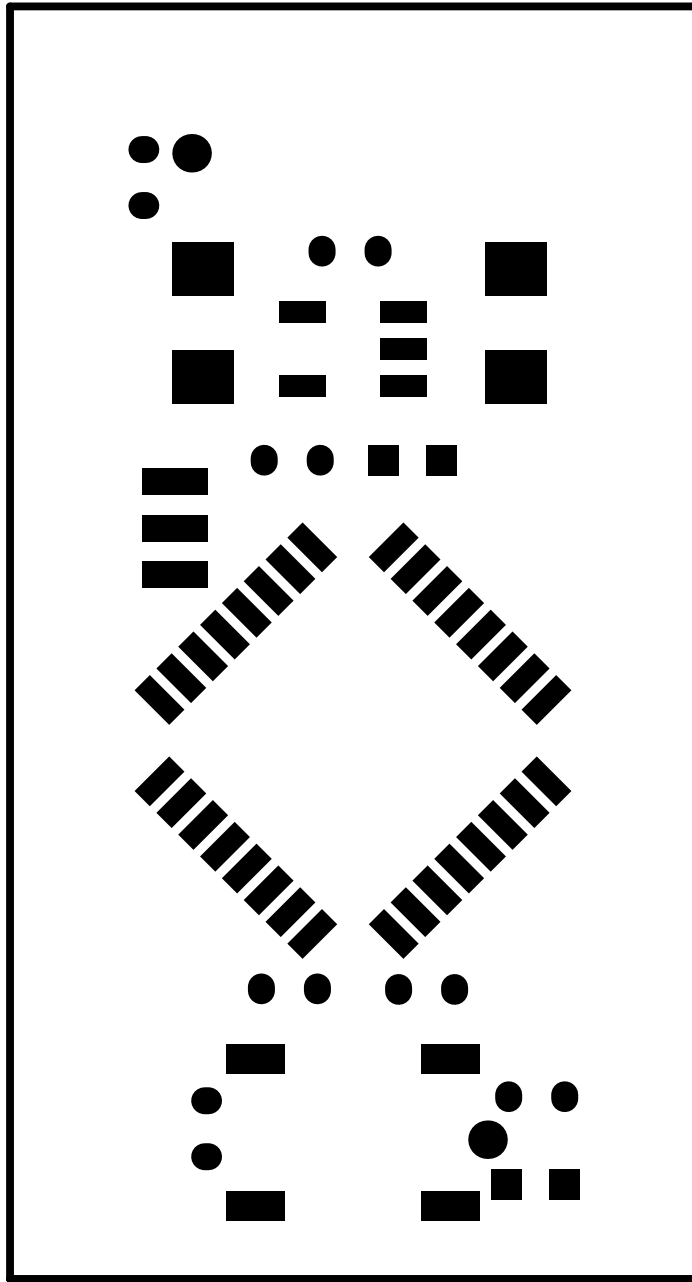

|                    |                       |                          |
|--------------------|-----------------------|--------------------------|
| PCB Information    | Name: DFRD159[V1.3]   | Thickness: 1.6mm         |
| Engineer: Strictus | Top SolderMask: Black | Bottom SolderMask: Black |
| Date: 20200812     | Top Silkscreen: White | Bottom Silkscreen: White |

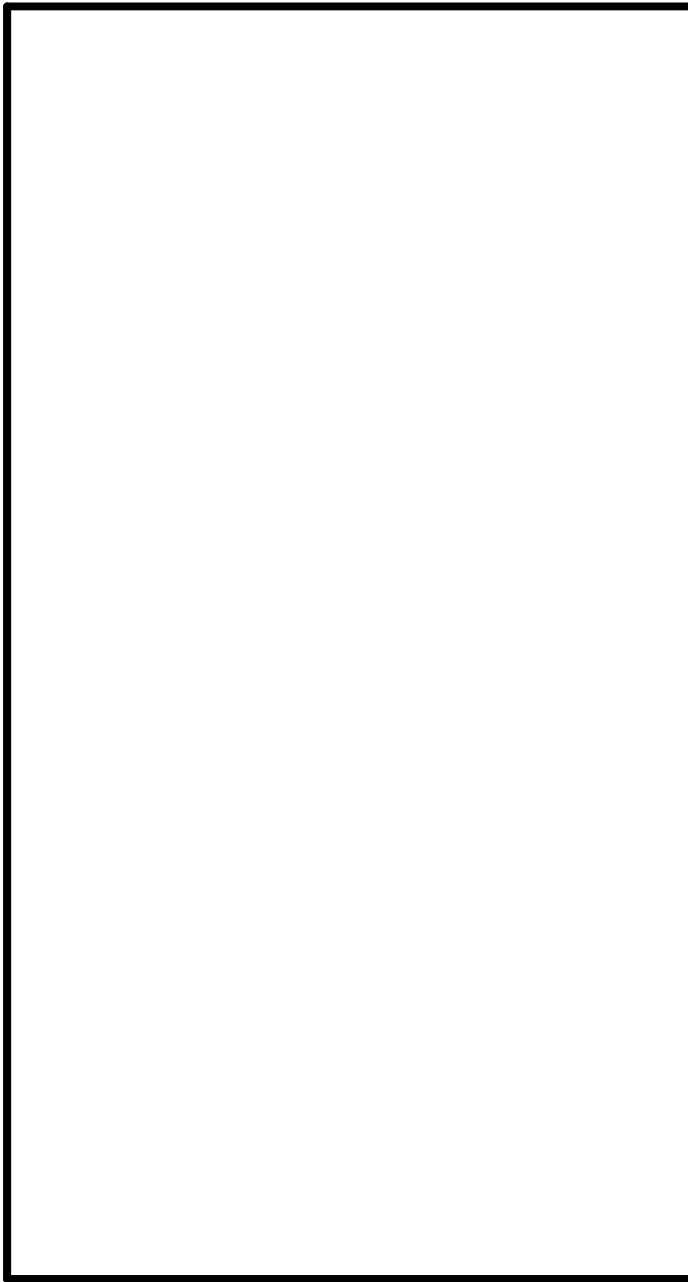

|                        |                       |                          |
|------------------------|-----------------------|--------------------------|
| <b>PCB Information</b> | Name: DFR0159[V1.3]   | Thickness: 1.6mm         |
| Engineer: Strictus     | Top SolderMask: Black | Bottom SolderMask: Black |
| Date: 20200812         | Top Silkscreen: White | Bottom Silkscreen: White |

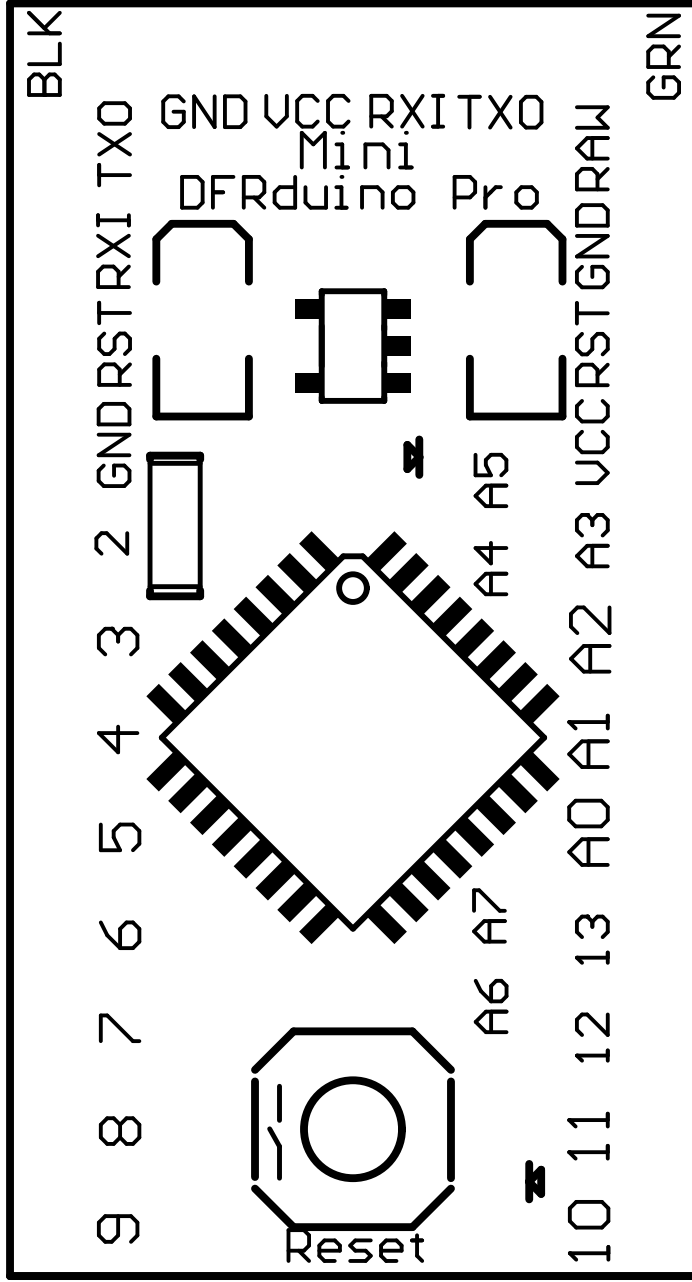

|                        |                       |                          |
|------------------------|-----------------------|--------------------------|
| <b>PCB Information</b> | Name: DFRD159[V1.3]   | Thickness: 1.6mm         |
| Engineer: Strictus     | Top SolderMask: Black | Bottom SolderMask: Black |
| Date: 20200812         | Top Silkscreen: White | Bottom Silkscreen: White |

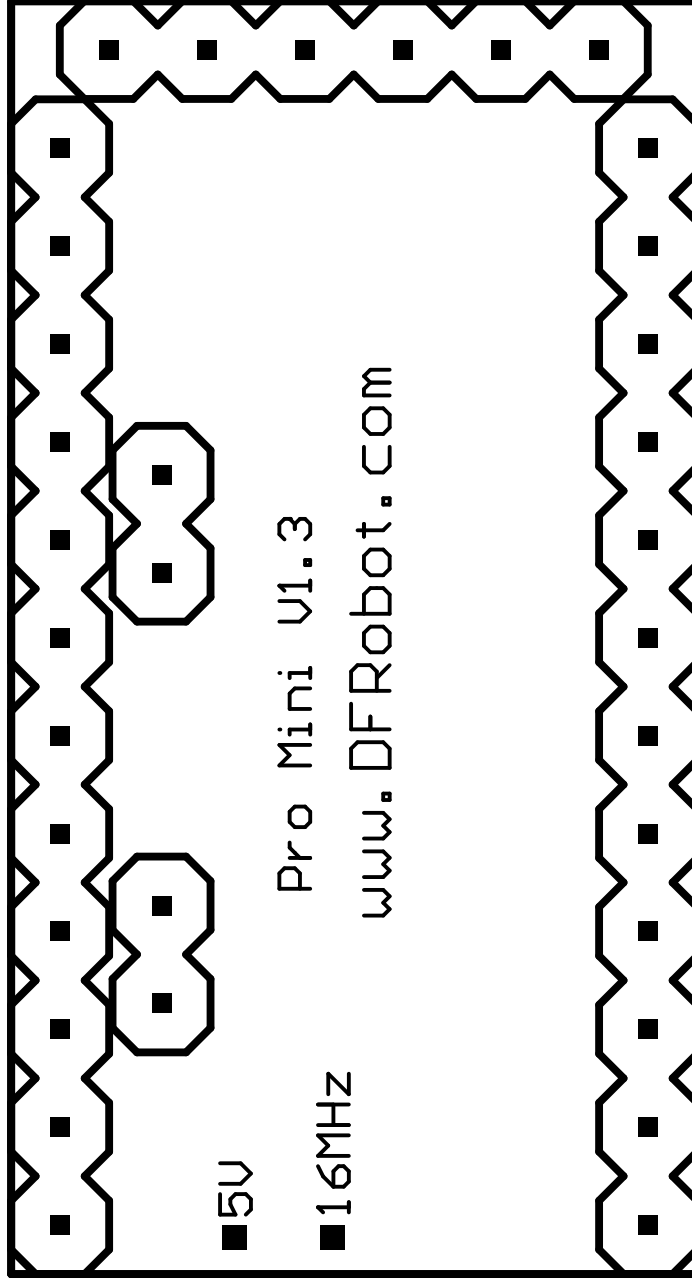

|                        |                       |                          |
|------------------------|-----------------------|--------------------------|
| <b>PCB Information</b> | Name: DFR0159[V1.3]   | Thickness: 1.6mm         |
| Engineer: Strictus     | Top SolderMask: Black | Bottom SolderMask: Black |
| Date: 20200812         | Top Silkscreen: White | Bottom Silkscreen: White |



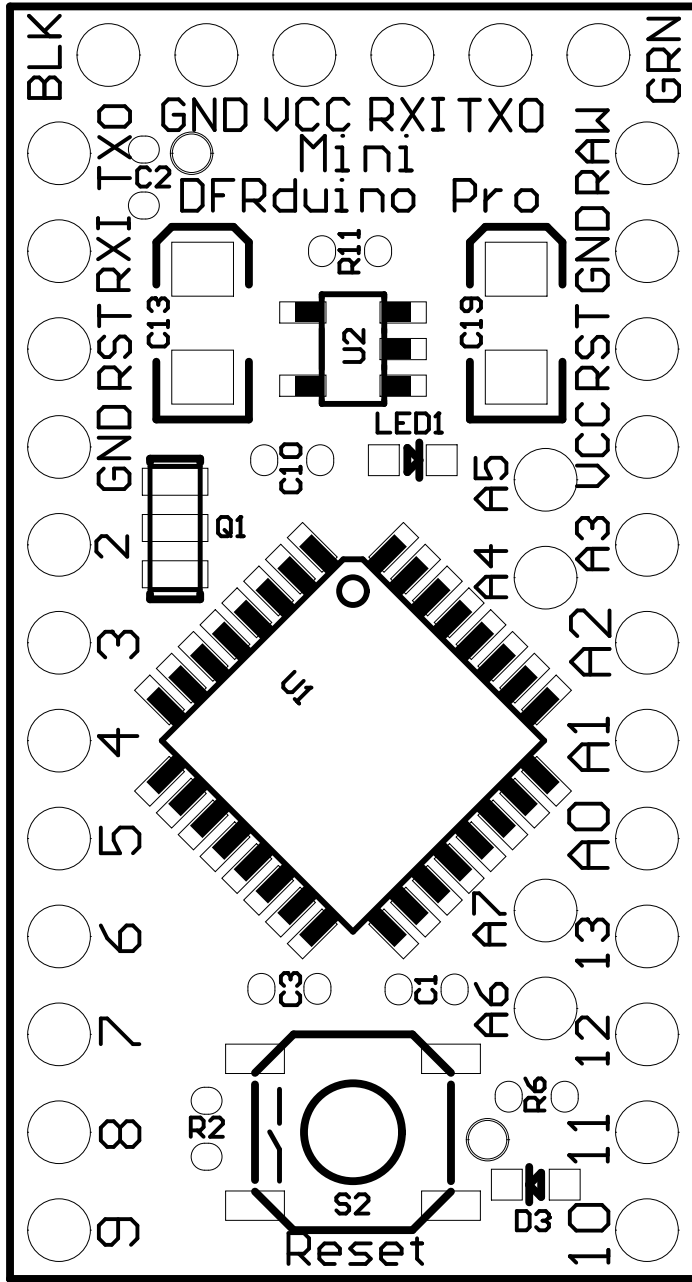

| PCB Information    | Name: DFRD159[V1.3]   | Thickness: 1.6mm         |
|--------------------|-----------------------|--------------------------|
| Engineer: Strictus | Top SolderMask: Black | Bottom SolderMask: Black |
| Date: 20200812     | Top Silkscreen: White | Bottom Silkscreen: White |

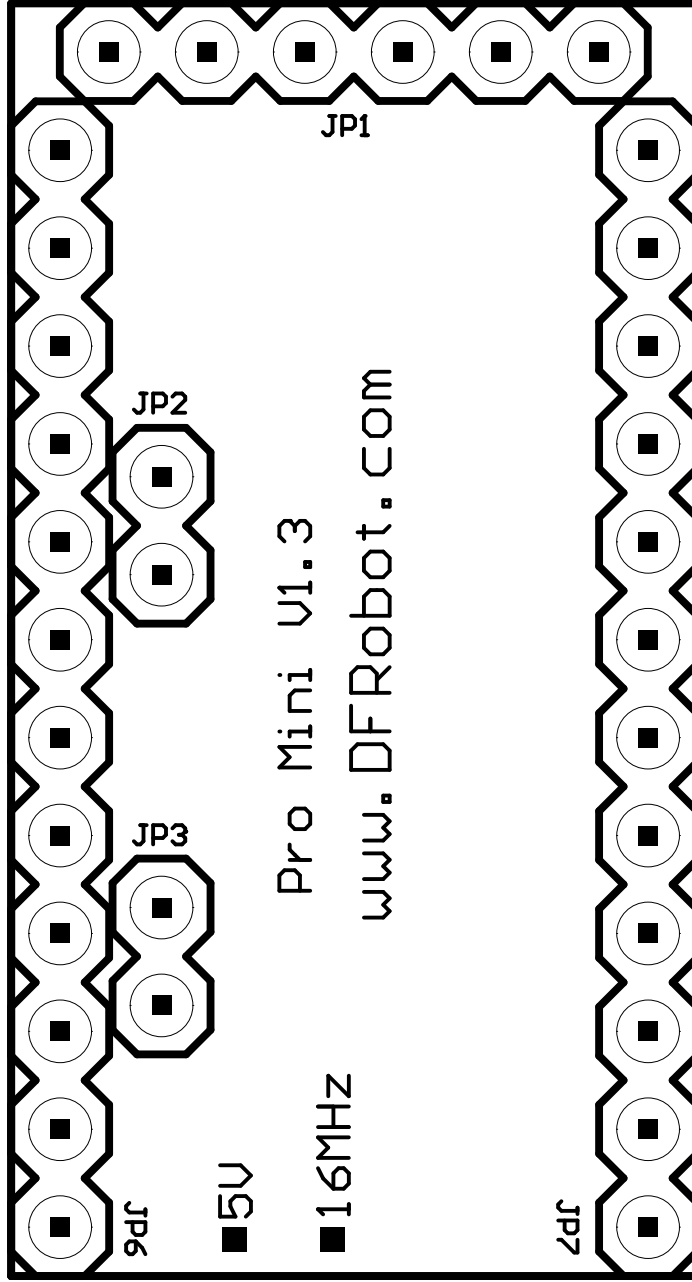

|                        |                       |                          |
|------------------------|-----------------------|--------------------------|
| <b>PCB Information</b> | Name: DFR0159[V1.3]   | Thickness: 1.6mm         |
| Engineer: Strictus     | Top SolderMask: Black | Bottom SolderMask: Black |
| Date: 20200812         | Top Silkscreen: White | Bottom Silkscreen: White |

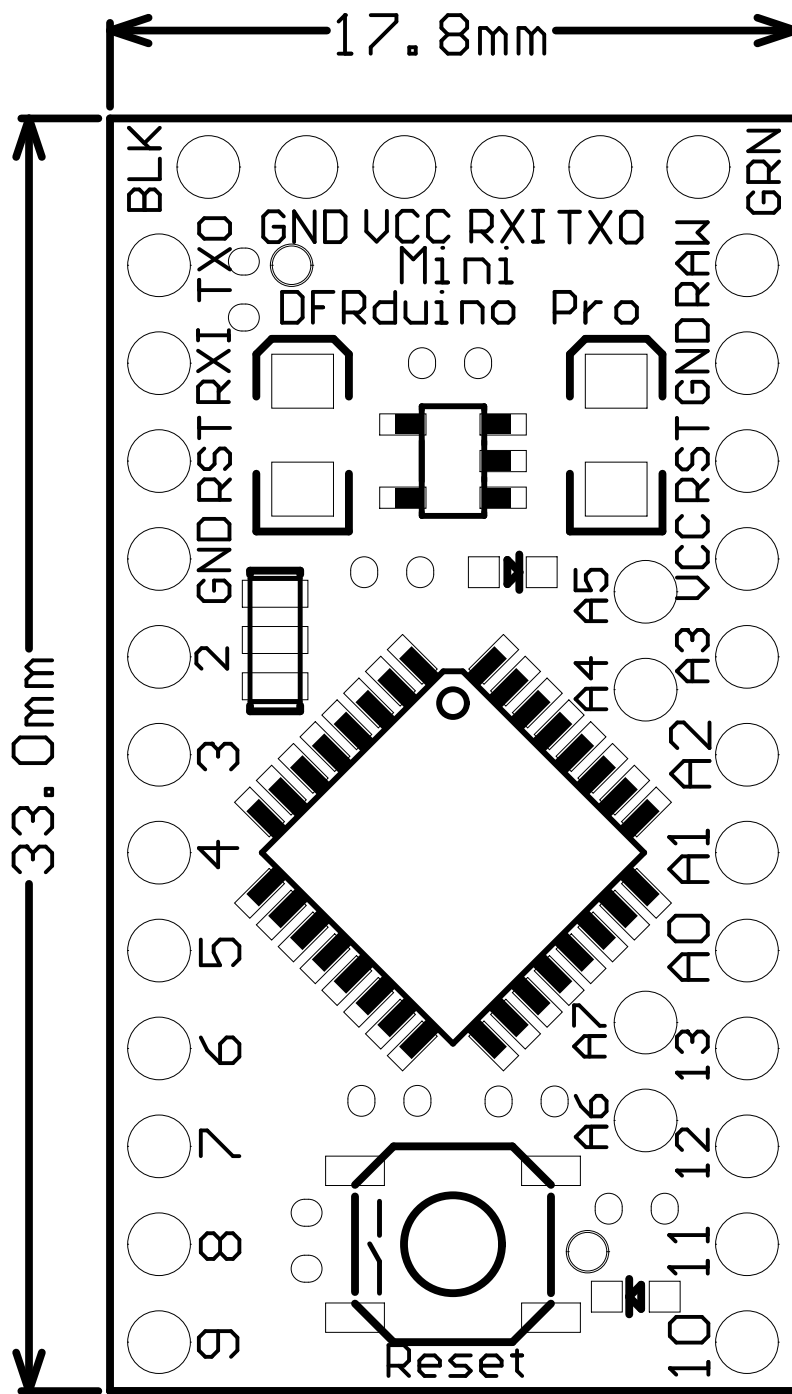

| PCB Information    | Name: DFRD159[V1.3]   | Thickness: 1.6mm         |
|--------------------|-----------------------|--------------------------|
| Engineer: Strictus | Top SolderMask: Black | Bottom SolderMask: Black |
| Date: 20200812     | Top Silkscreen: White | Bottom Silkscreen: White |

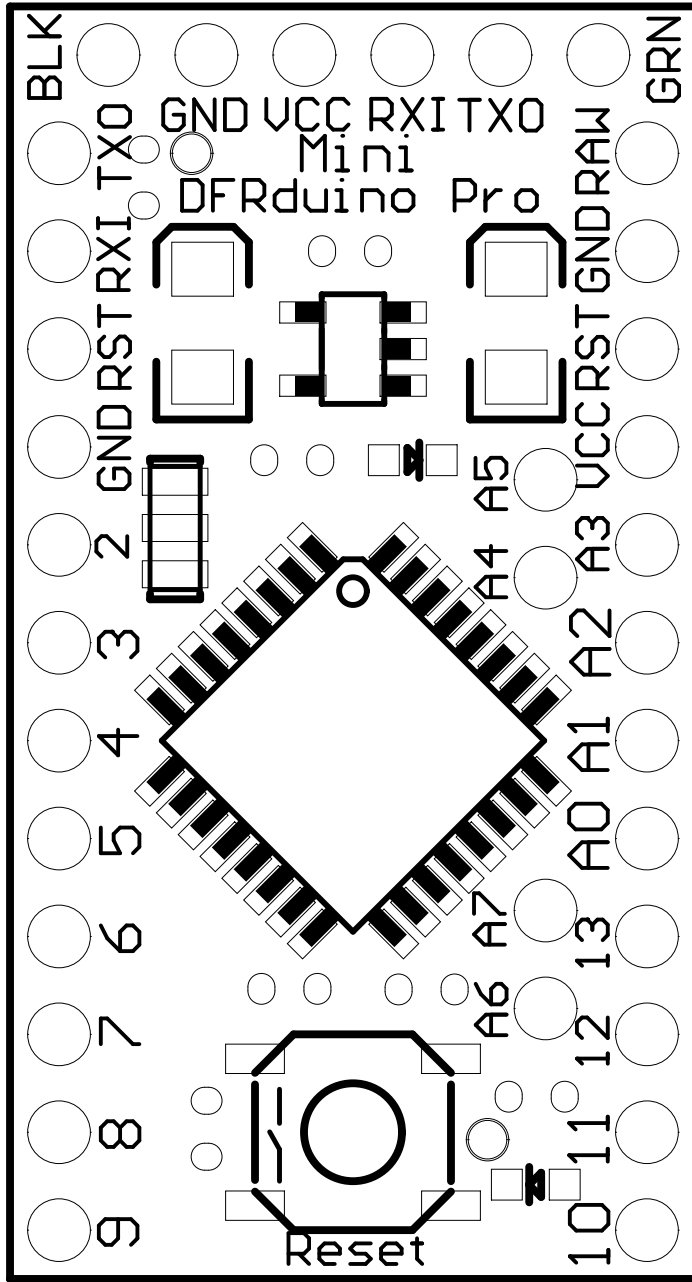

| PCB Information    | Name: DFRD159[V1.3]   | Thickness: 1.6mm         |
|--------------------|-----------------------|--------------------------|
| Engineer: Strictus | Top SolderMask: Black | Bottom SolderMask: Black |
| Date: 20200812     | Top Silkscreen: White | Bottom Silkscreen: White |

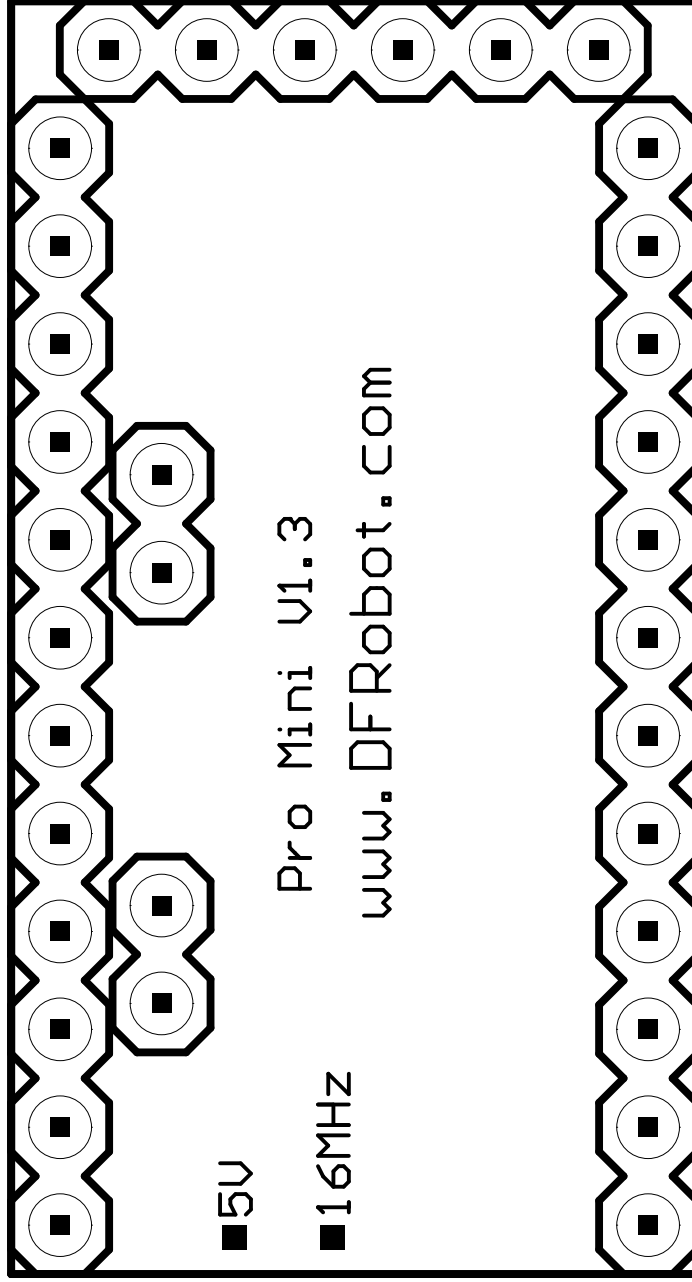

|                        |                       |                          |
|------------------------|-----------------------|--------------------------|
| <b>PCB Information</b> | Name: DFR0159[V1.3]   | Thickness: 1.6mm         |
| Engineer: Strictus     | Top SolderMask: Black | Bottom SolderMask: Black |
| Date: 20200812         | Top Silkscreen: White | Bottom Silkscreen: White |