

Title: Lithium Battery Charger	Code: DFR0208
Drawn: Aaron-CD	Size: A3
Page: 1 of 1	Time: 10:03:03
Date: 2023/3/27	

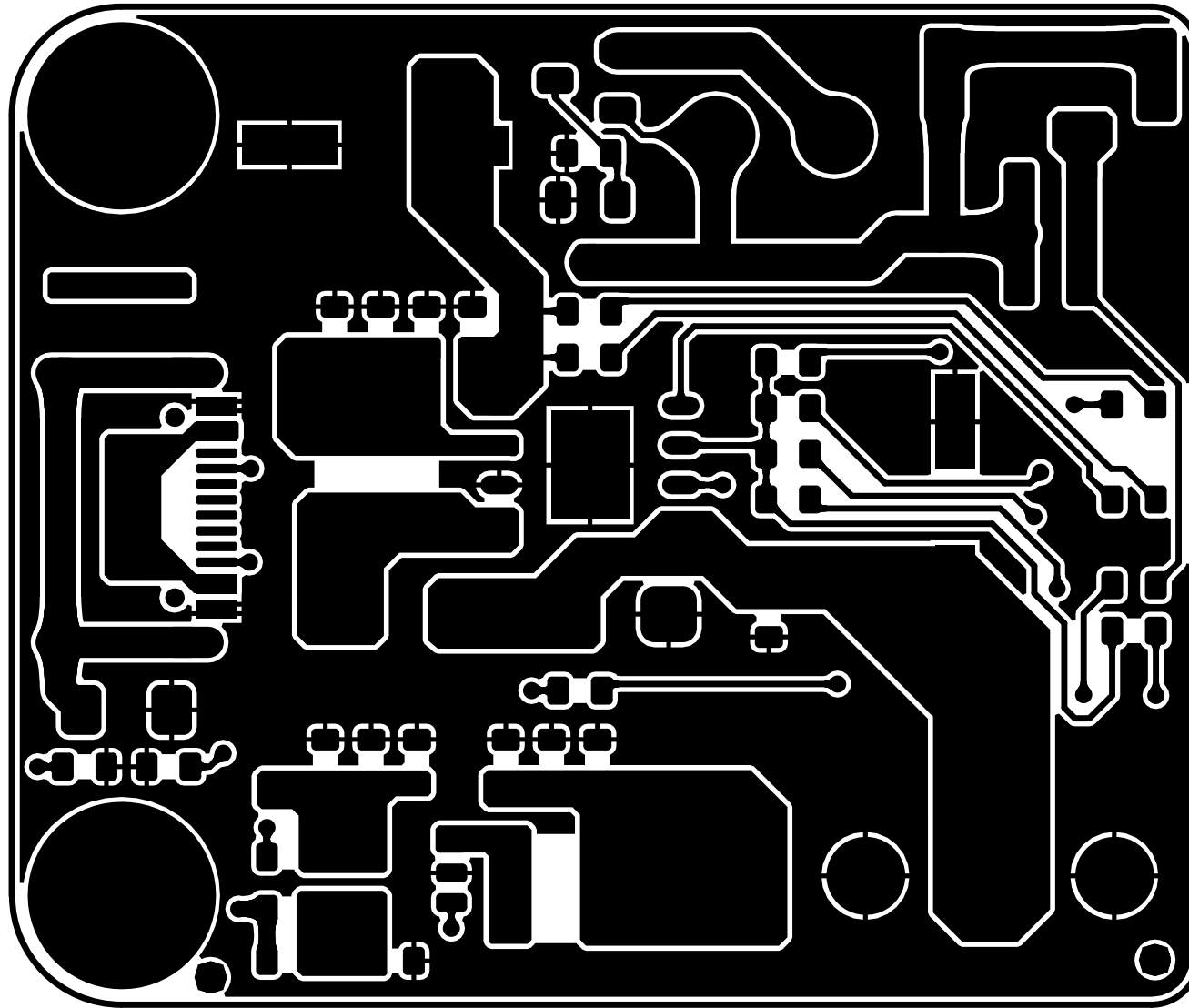

<b>PCB Information</b>	Name:[DFR0208](V1.0.0)	Thickness: 1.6mm
Engineer:Aaron	Top SolderMask: Black	Bottom SolderMask: Black
Date: 20230324	Top Silkscreen: White	Bottom Silkscreen: White

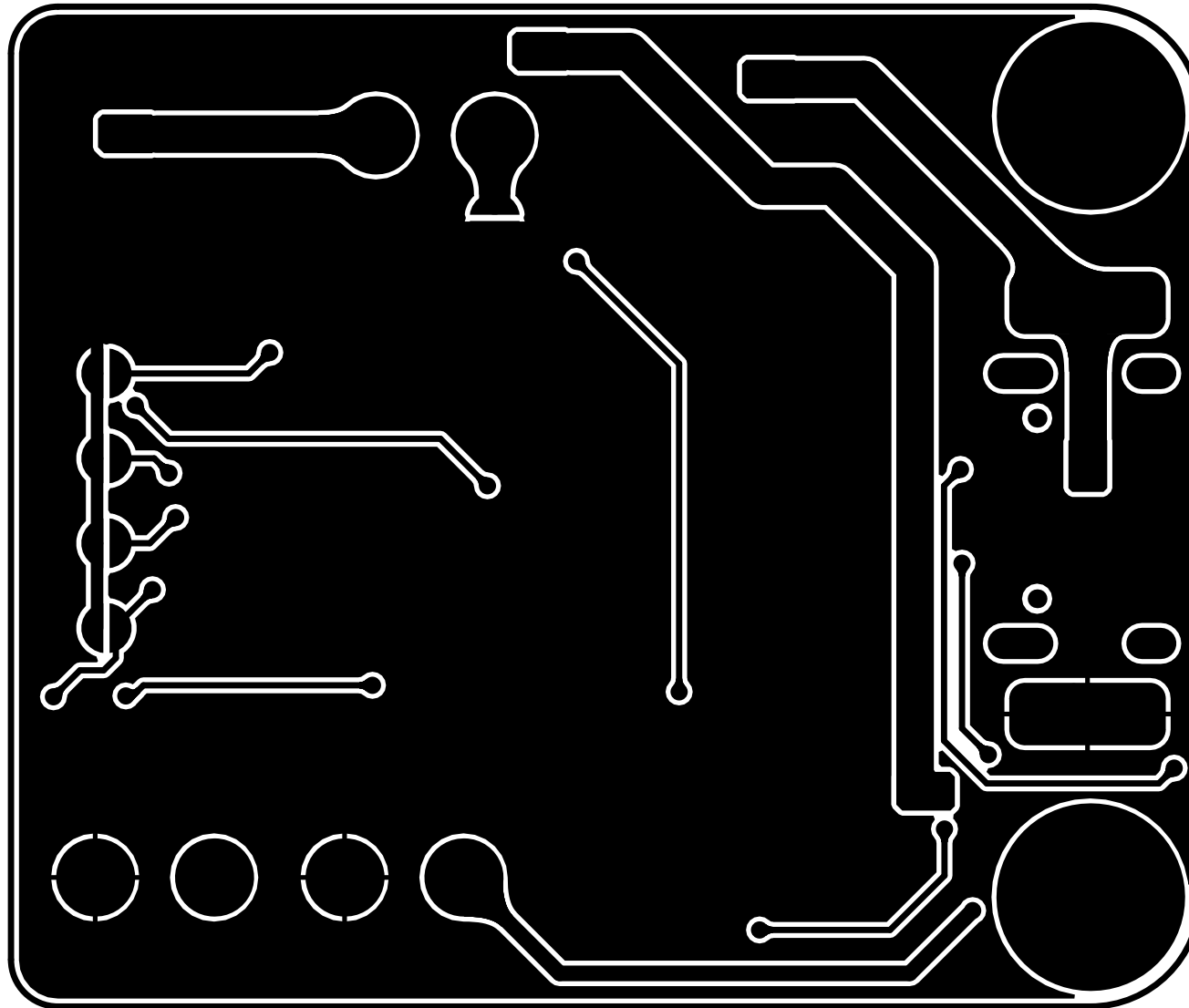

<b>PCB Information</b>	Name:[DFR0208](V1.0.0)	Thickness: 1.6mm
Engineer:Aaron	Top SolderMask: Black	Bottom SolderMask: Black
Date: 20230324	Top Silkscreen: White	Bottom Silkscreen: White

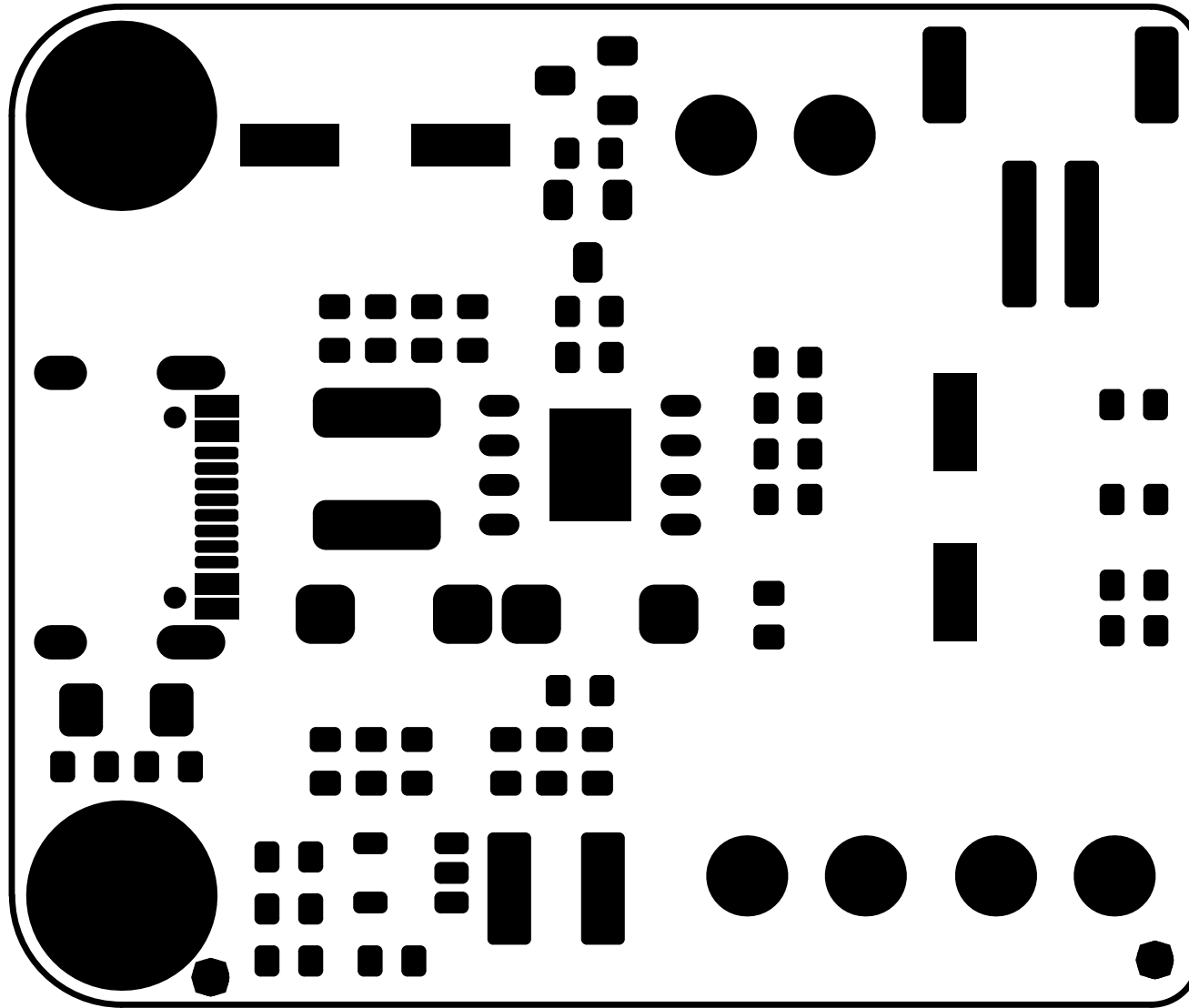

<b>PCB Information</b>	Name:[DFR0208](V1.0.0)	Thickness: 1.6mm
Engineer:Aaron	Top SolderMask: Black	Bottom SolderMask: Black
Date: 20230324	Top Silkscreen: White	Bottom Silkscreen: White

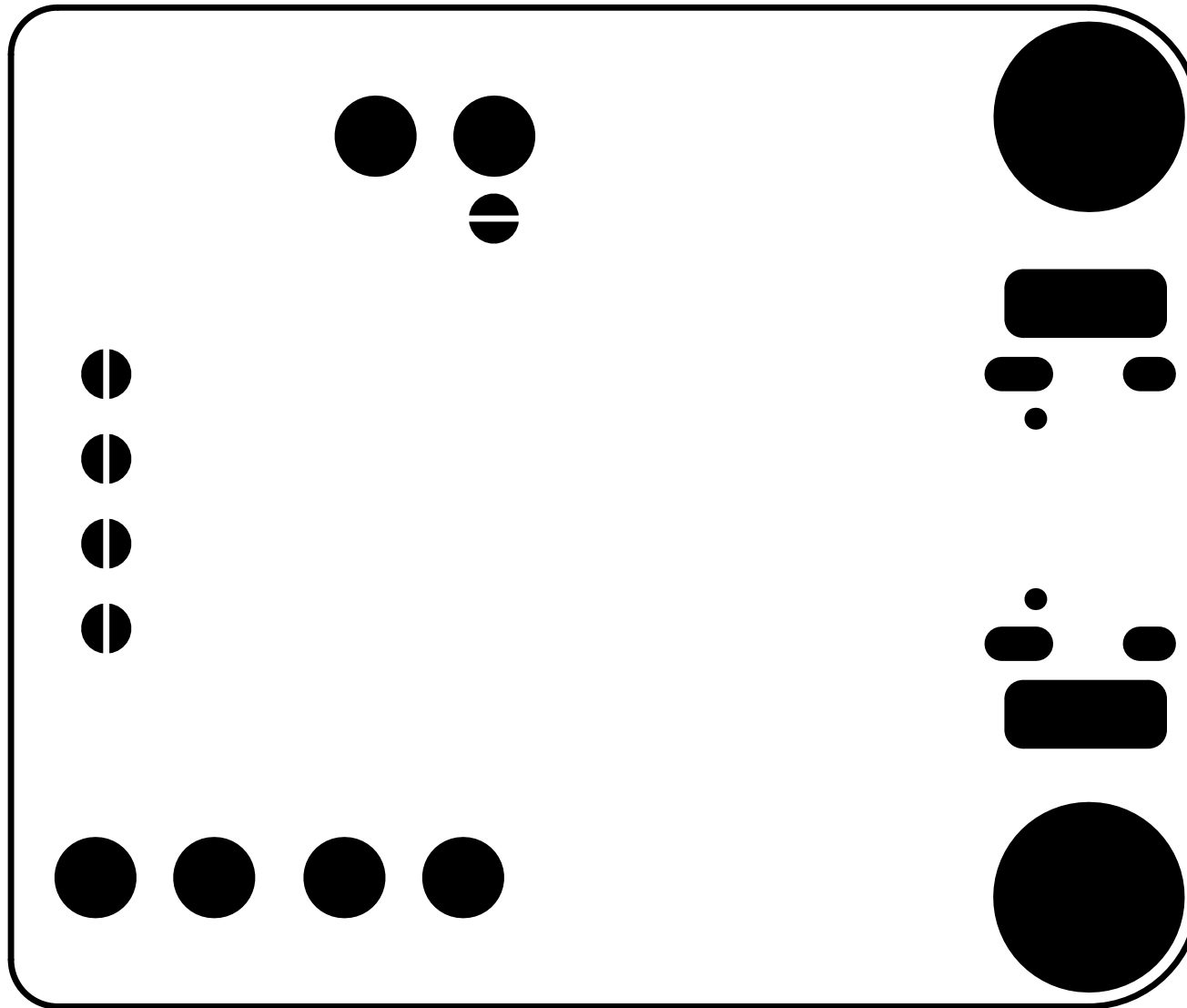

<b>PCB Information</b>	Name:[DFR0208](V1.0.0)	Thickness: 1.6mm
Engineer:Aaron	Top SolderMask: Black	Bottom SolderMask: Black
Date: 20230324	Top Silkscreen: White	Bottom Silkscreen: White

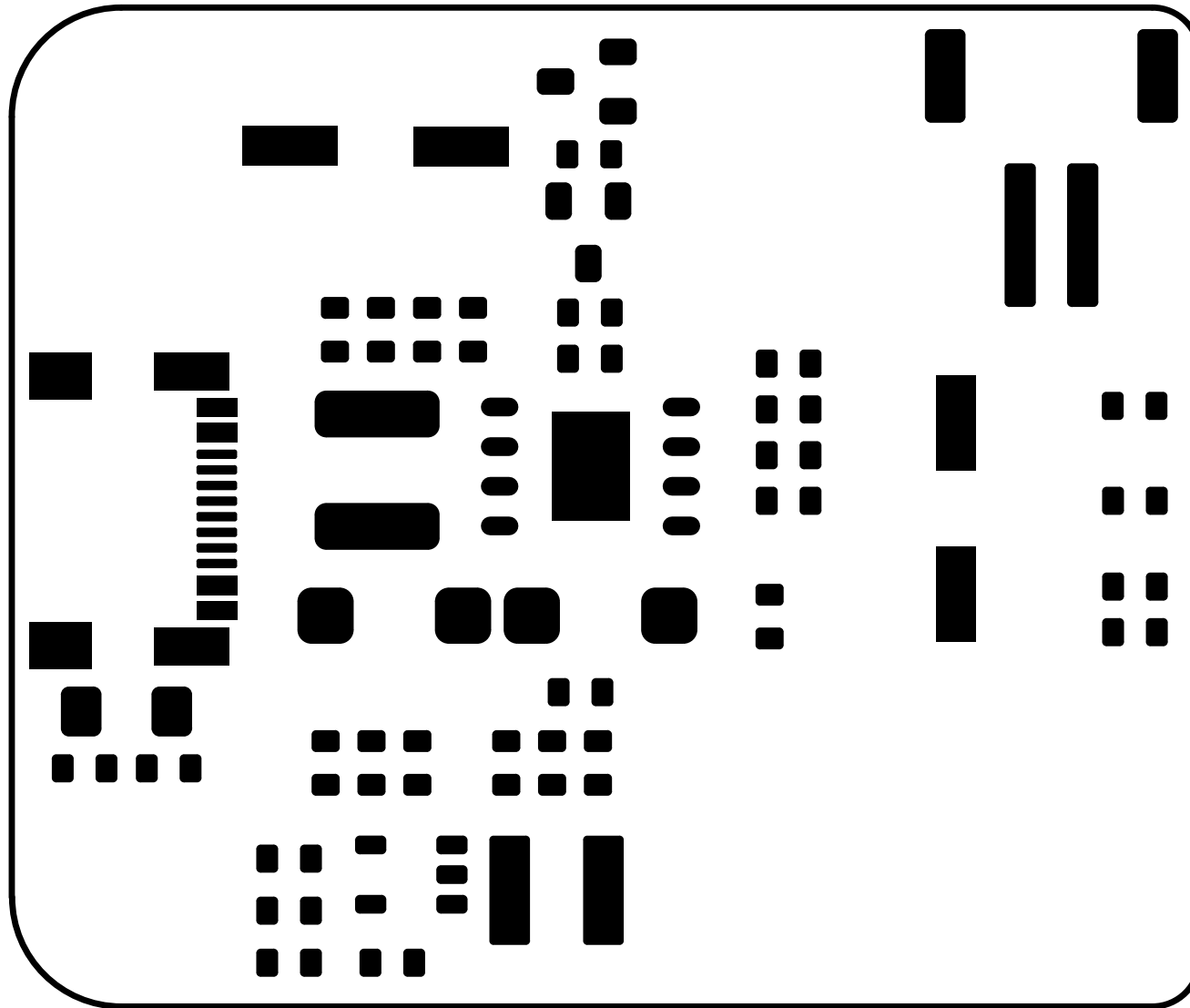

<b>PCB Information</b>	Name:[DFR0208](V1.0.0)	Thickness: 1.6mm
Engineer:Aaron	Top SolderMask: Black	Bottom SolderMask: Black
Date: 20230324	Top Silkscreen: White	Bottom Silkscreen: White

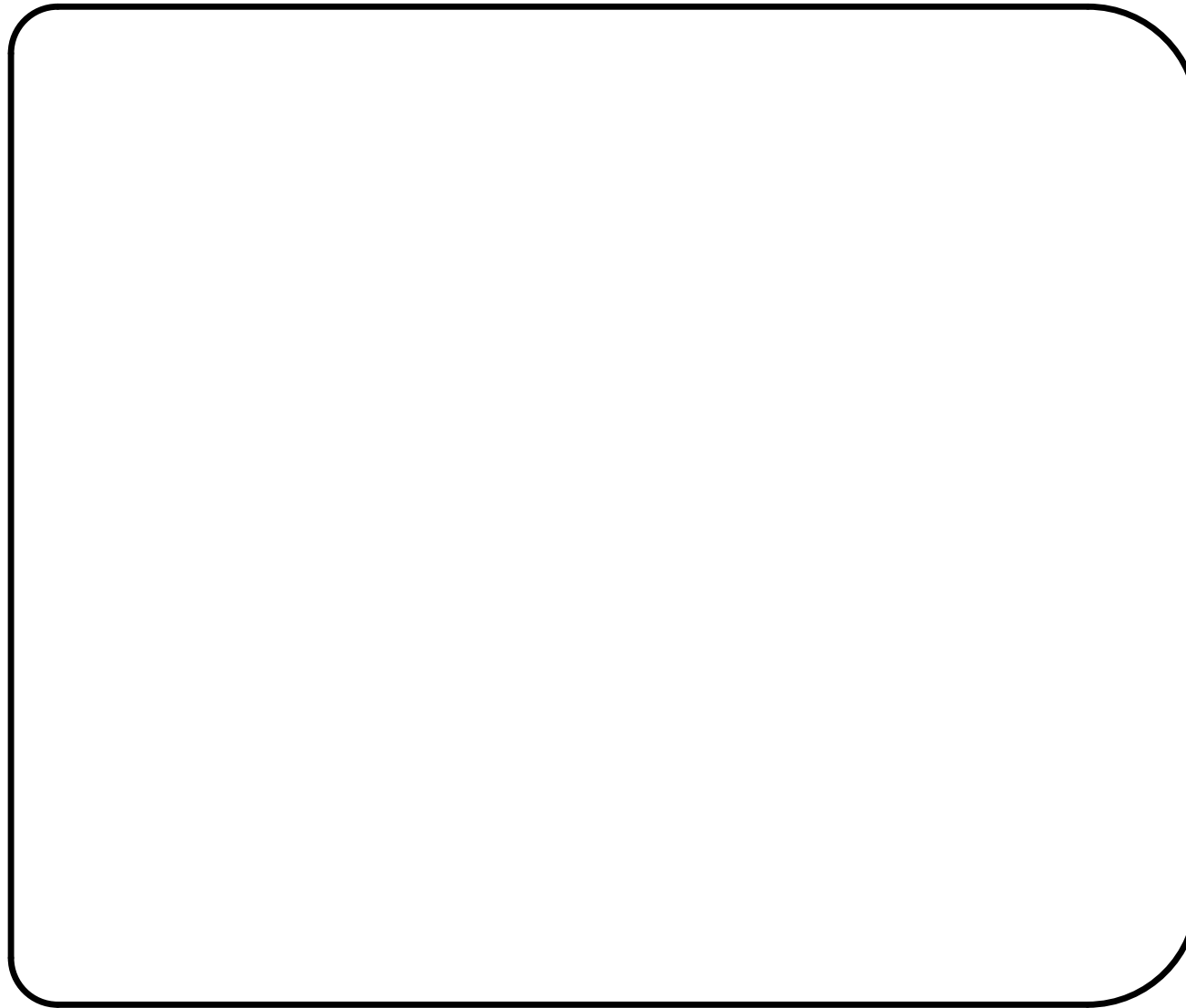

<b>PCB Information</b>	Name:[DFR0208](V1.0.0)	Thickness: 1.6mm
Engineer:Aaron	Top SolderMask: Black	Bottom SolderMask: Black
Date: 20230324	Top Silkscreen: White	Bottom Silkscreen: White

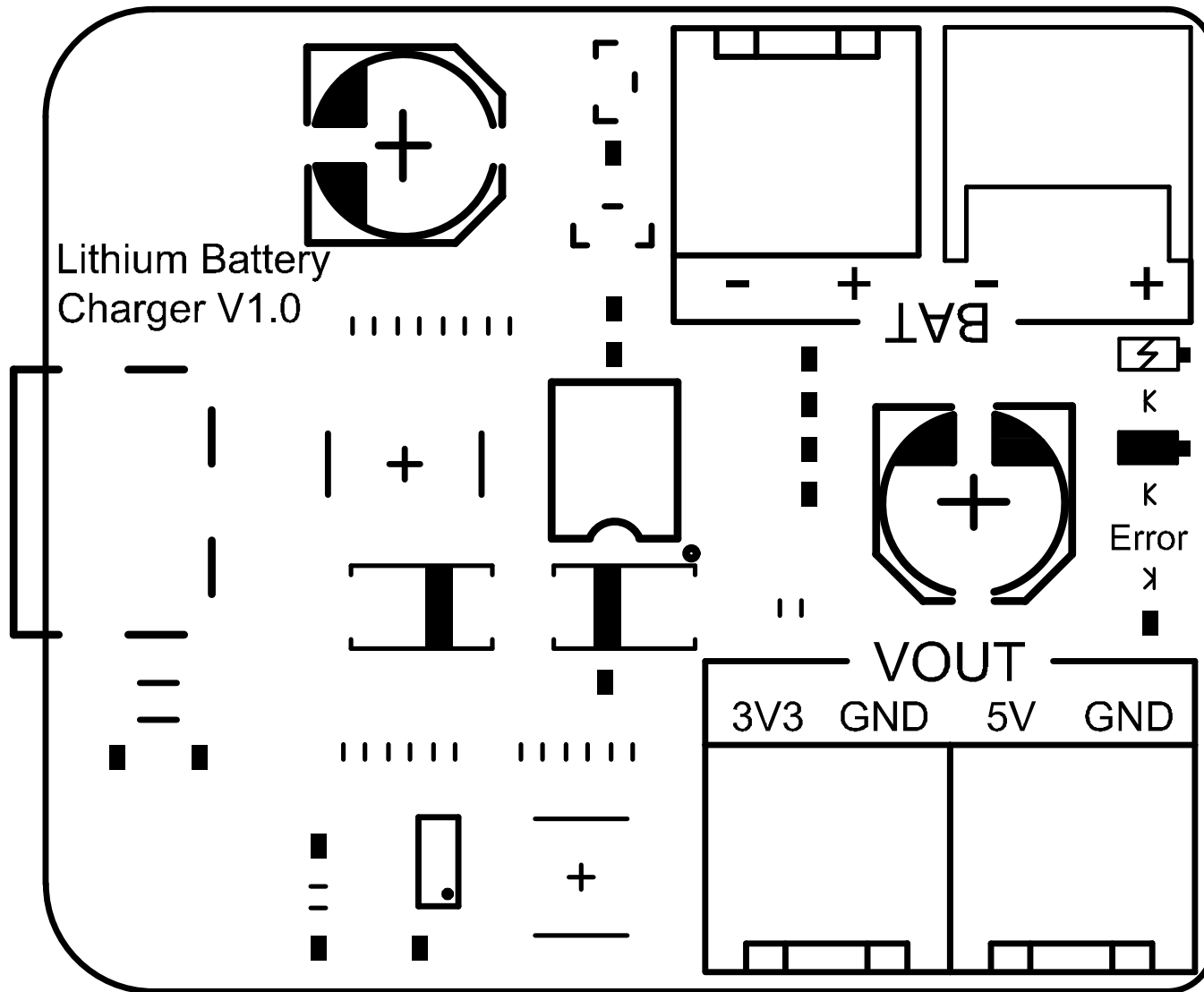

<b>PCB Information</b>	Name:[DFR0208](V1.0.0)	Thickness: 1.6mm
Engineer:Aaron	Top SolderMask: Black	Bottom SolderMask: Black
Date: 20230324	Top Silkscreen: White	Bottom Silkscreen: White



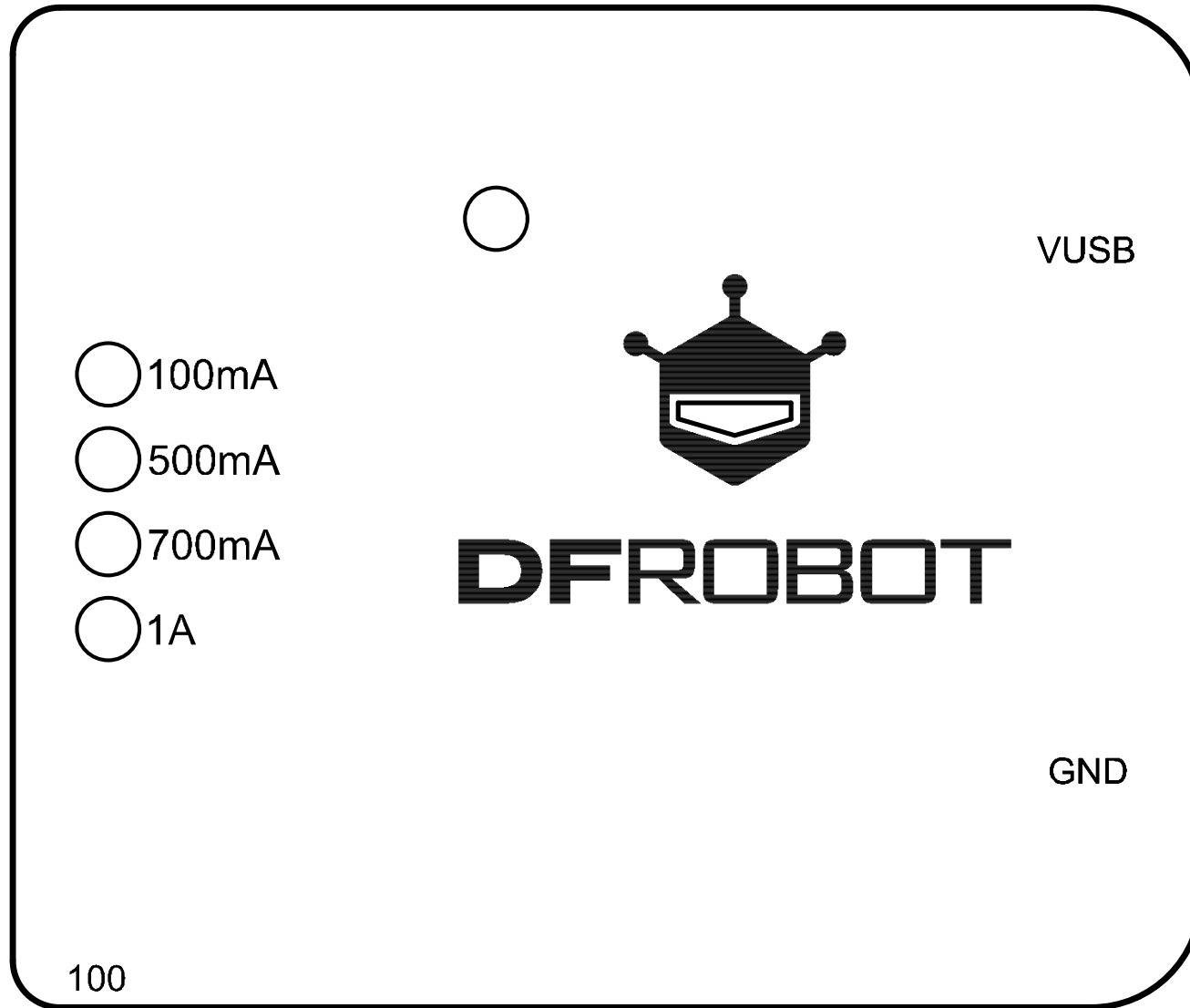

<b>PCB Information</b>	Name:[DFR0208](V1.0.0)	Thickness: 1.6mm
Engineer:Aaron	Top SolderMask: Black	Bottom SolderMask: Black
Date: 20230324	Top Silkscreen: White	Bottom Silkscreen: White

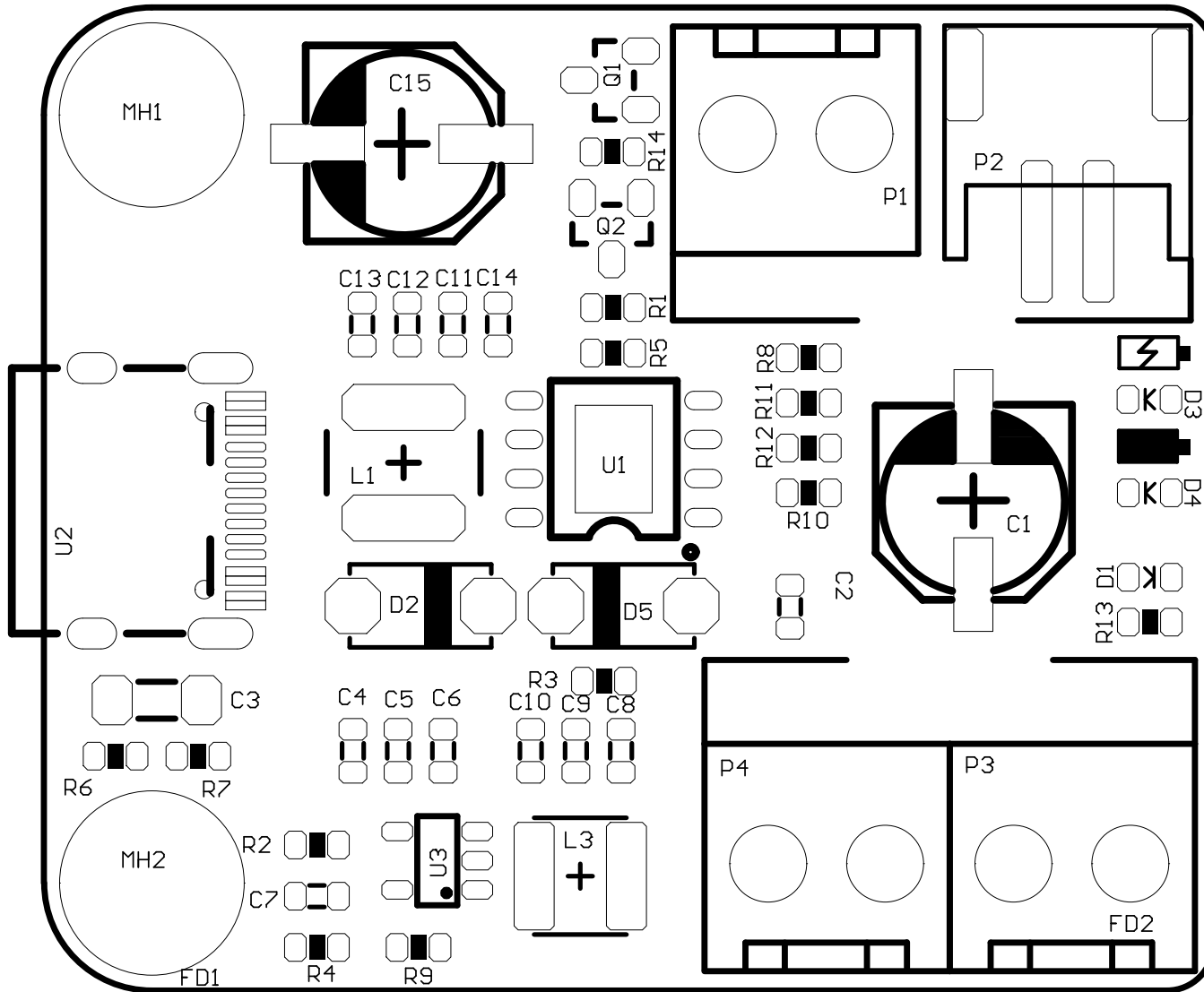

<b>PCB Information</b>	Name:[DFR0208](V1.0.0)	Thickness: 1.6mm
Engineer:Aaron	Top SolderMask: Black	Bottom SolderMask: Black
Date: 20230324	Top Silkscreen: White	Bottom Silkscreen: White

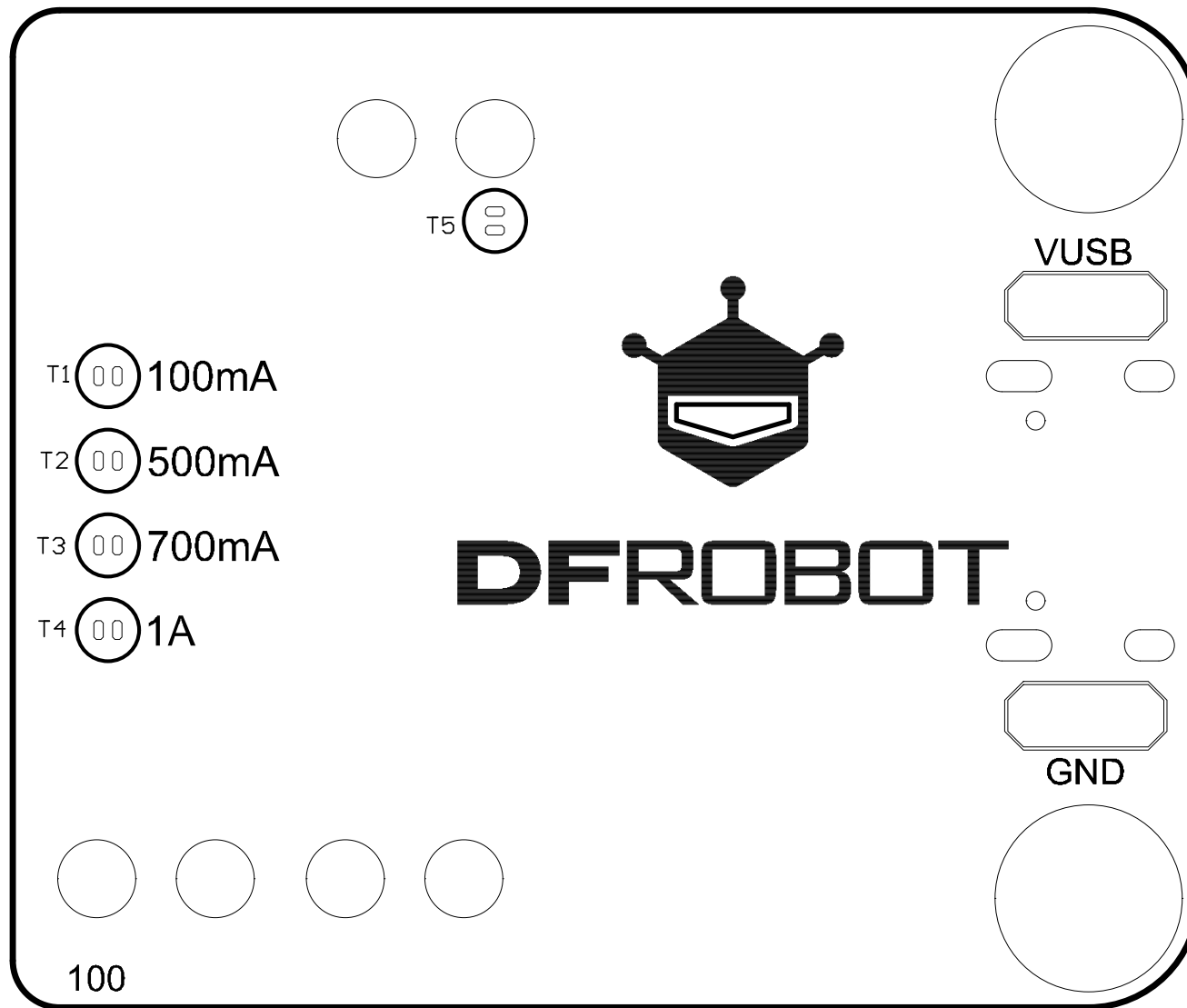

<b>PCB Information</b>	Name:[DFR0208](V1.0.0)	Thickness: 1.6mm
Engineer:Aaron	Top SolderMask: Black	Bottom SolderMask: Black
Date: 20230324	Top Silkscreen: White	Bottom Silkscreen: White

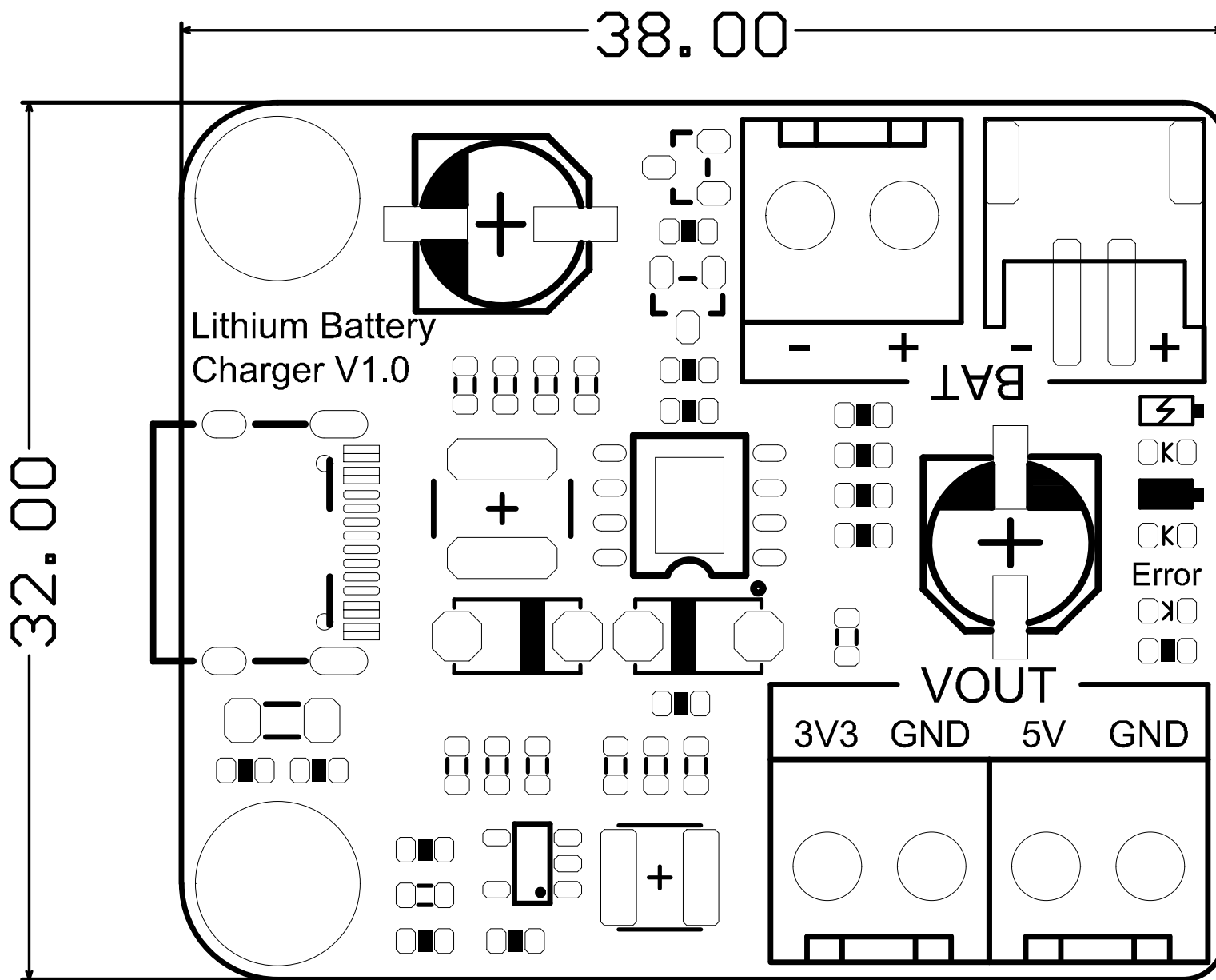

<b>PCB Information</b>	Name:[DFR0208](V1.0.0)	Thickness: 1.6mm
Engineer:Aaron	Top SolderMask: Black	Bottom SolderMask: Black
Date: 20230324	Top Silkscreen: White	Bottom Silkscreen: White

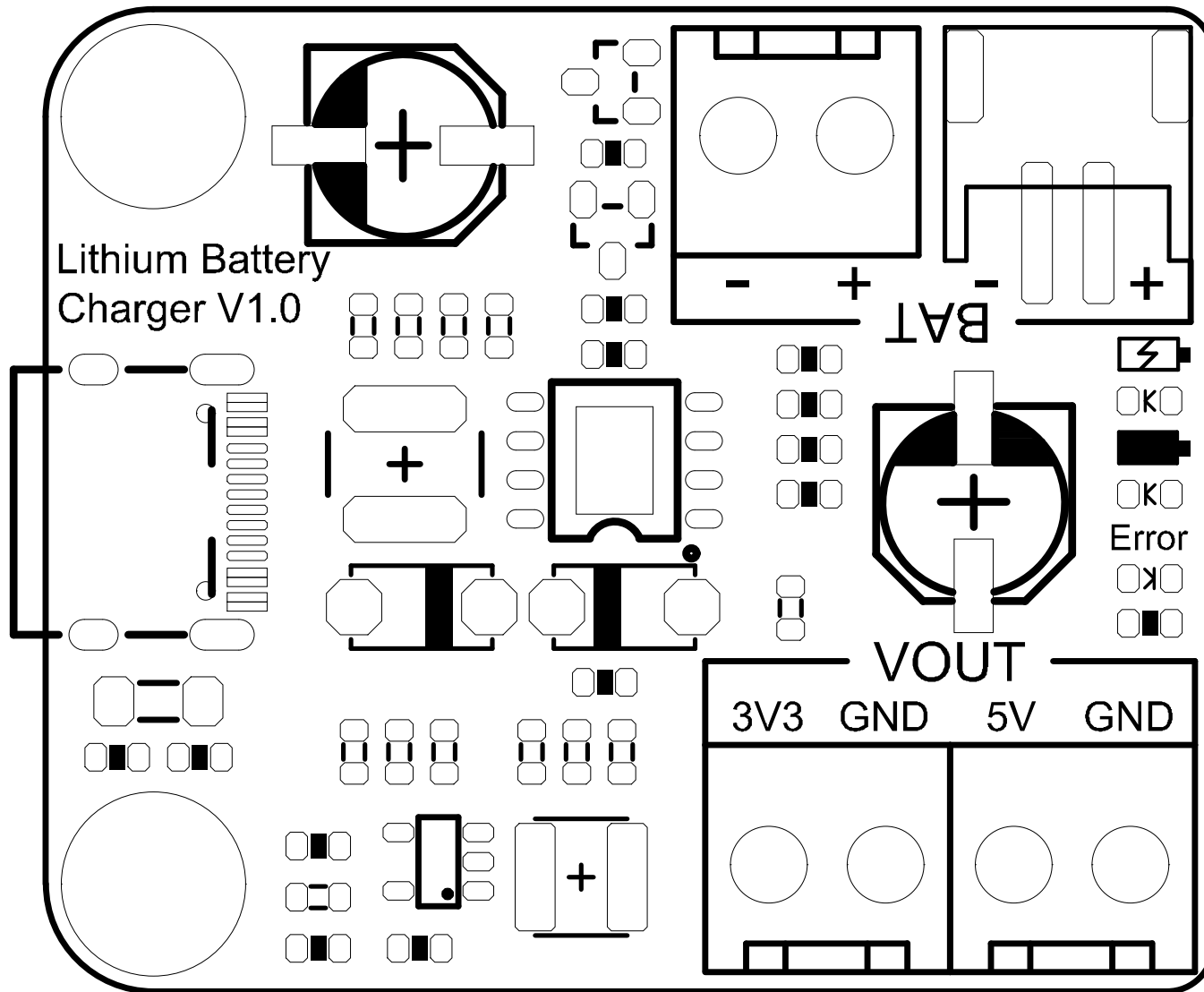

<b>PCB Information</b>	Name:[DFR0208](V1.0.0)	Thickness: 1.6mm
Engineer:Aaron	Top SolderMask: Black	Bottom SolderMask: Black
Date: 20230324	Top Silkscreen: White	Bottom Silkscreen: White

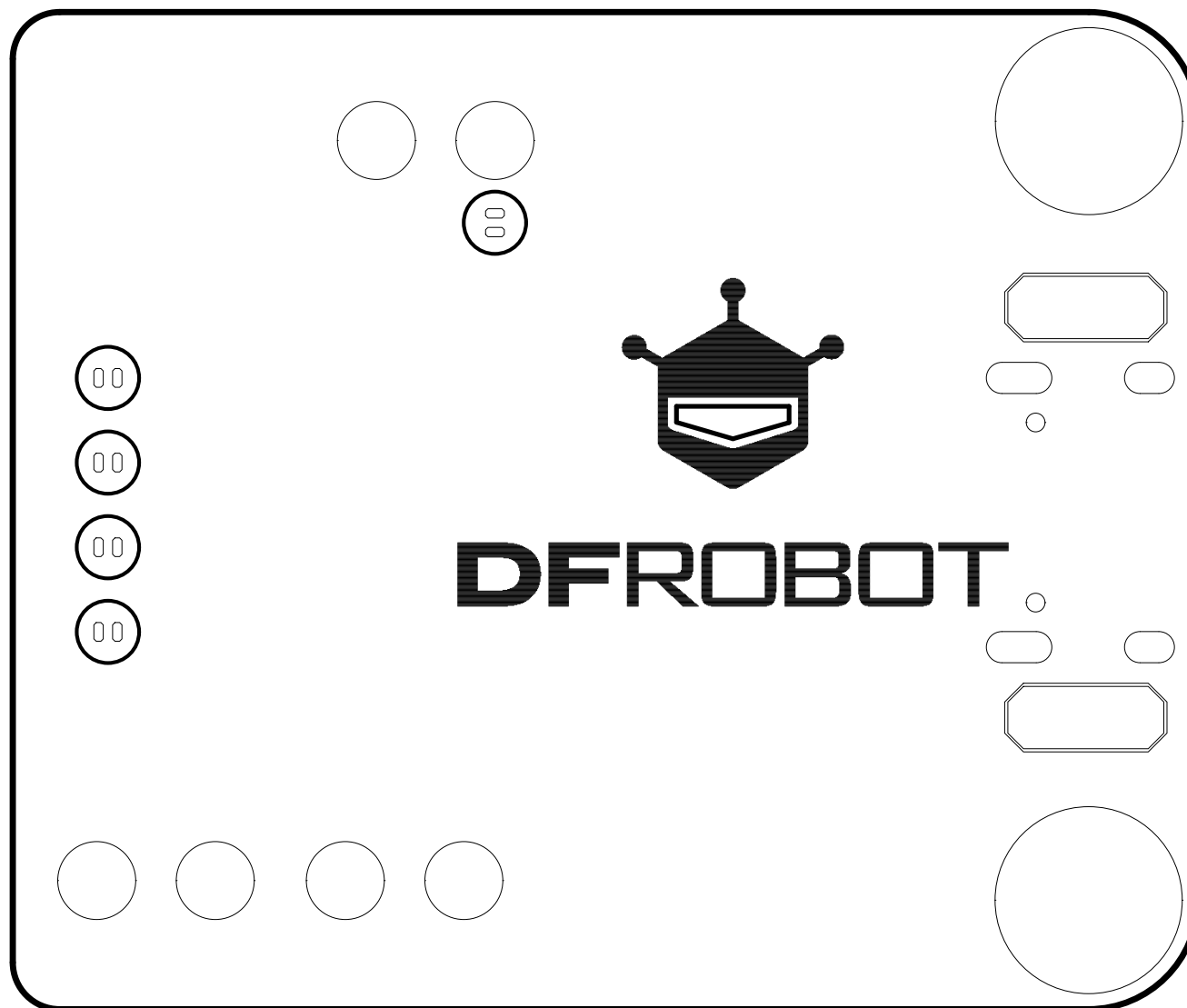

<b>PCB Information</b>	Name:[DFR0208](V1.0.0)	Thickness: 1.6mm
Engineer:Aaron	Top SolderMask: Black	Bottom SolderMask: Black
Date: 20230324	Top Silkscreen: White	Bottom Silkscreen: White